

SOPORTES PARA CABECERA CM **CH3 TR / CHM TR / CHR TR**
 SUPPORTS POUR TÊTE CM **CH3 TR / CHM TR / CHR TR**
 CHASSIS DI SUPPORTO PER CENTRALE CM **CH3 TR / CHM TR / CHR TR**
 SUPPORTS PARA CABECERIA CM **CH3 TR / CHM TR / CHR TR**
 CM HEADEND SERIES SUPPORT FRAMES **CH3 TR / CHM TR / CHR TR**

REFERENCIA	RÉFÉRENCE	ARTICOLO	REFERÊNCIA	REFERENCE	CH3 TR	CHM TR	CHR TR
Código	Code	Codice	Código	Code	220005	080005	080006
Descripción	Description	Descrizione	Descrição	Description	Chasis mural 3 módulos serie CM	Chasis mural 6 módulos serie CM	Chassis rack 6 módulos serie CM
Número de módulos	Nombre de modules	Numero di moduli	Número de módulos	Number of modules	2 + Fuente / PSU	5 + Fuente / PSU	5 + Fuente / PSU
Montaje	Installation	Installazione	Instalação	Installation	Pared / Wall		Rack 19" (6U)
Medidas	Dimensions	Dimensioni	Dimensões	Dimensions	187x265x26 mm	427x265x26 mm	475x265x200 mm
Material	Matériel	Materiale	Material	Material	Hierro galvanizado / galvanized iron		

[ES] Instalar el chasis en un espacio fresco y seco y alejado (>2m) de fuentes de interferencia electromagnética (transformadores, motores, antenas transmisoras,...).

[FR] Monter le chassis dans un endroit frais et éloigné (>2m) des sources de champs électromagnétiques (transformateurs, moteurs, antennes d'émission)

[IT] Installare lo chassis in un luogo fresco e asciutto, lontano (>2m) da possibili fonti di interferenza elettromagnetica (trasformatori, motori, antenne trasmettenti,...).

[PT] Instale o chassis em um lugar fresco e seco, afastado (>2m) de fontes de interferência eletromagnéticas (transformadores, motores, antenas de radiodifusão,...).

[EN] Mount the chassis in a cool, dry and distant space (>2m) from sources of electromagnetic interference (transformers, motors, transmitting antennas,...).

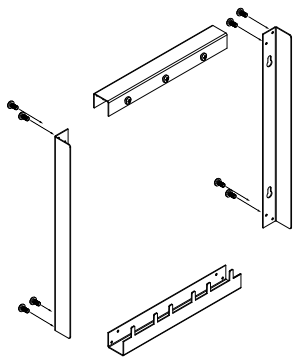

CH3 TR

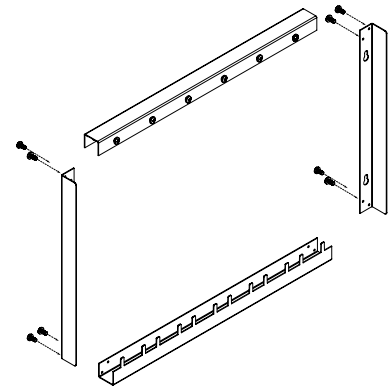
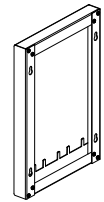

CHM TR

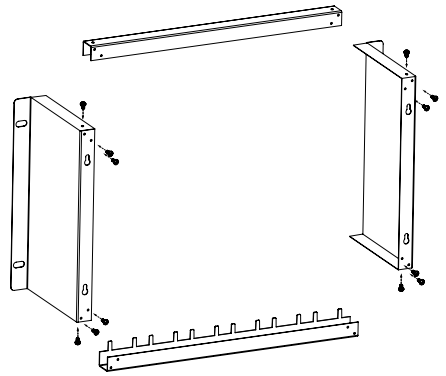
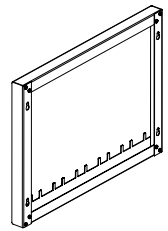

CHR TR

