



EKSELANS BY ITS



# GPON

byEk

ENTER THE EK WORLD

# MANAGED SWITCH

REFERENCE		SWG 24 L2
Code		334200
Ports	Mbps	24 x 10/100/1000
Port functions		IEEE 802.3 para Ethernet IEEE 802.3u para Fast Ethernet IEEE 802.3u por IEEE 802.3ab GB Ethernet MDI/MDIX automático El control de flujo IEEE 802.3x admite el modo dúplex completo Admite operación de dúplex medio/completo (la mitad a 10/100 Mbps, completo a 1000 Mbps)
Switching Capacity	Gbps	56
Max Forwarding Rate	Mpps	41,66
MAC Address Table size		8K
Packet buffer	MB	4
Flash Memory	MB	16
Standby Mode	W	6,143
Maximum Power Consumption	W	16,34
Power input		Fuente de alimentación interna de 100 a 240 V CA, 50 a 60 Hz
MTBF		415,670 h
VLAN		Port-based VLAN 802.1Q tagged VLAN Auto Surveillance VLAN Voice VLAN Management VLAN Max. 4094 VLAN
L2 Features		- Control de flujo IGMP Snooping V1/V2/V3 / Admite 256 grupos MLD snooping Link aggregation - Loopback detection - LLDP Spanning tree 802.1D STP / 802.1w RSTP / 802.1s MSTP QOS Port mirroring
Security		DDOS ACL
Management		WEB, SSH, TELNET, SNMP.
Heat dissipation		55.77 BTU/h
Ventilation		Sin ventilador
Operating temperature	°C	0 - 50
Humidity	%	10 - 90 (sin condensación)
Max dissipation	BTU/h	7,03
Dimensions	mm	440 x 280 x 44
Weight	Kg	2,295

## SWG 24 L2

- ✓ 24 Port 10/100/1000Mbps + 4 SFP port
- ✓ Layer 2+ function for an efficient routing
- ✓ Standard IEEE802.3, 802.3u, 802.3ab, 802.3x.
- ✓ VLAN management, IGMP snooping, MACs admin, port mirroring.....
- ✓ Web management interface, SSH, TELNET, SNMP
- ✓ 1U / Rack 19"
- ✓ Multi-cast facilities (companies, hotels, hospitals, SoHo,..)
- ✓ Suitable product to include in GPON by EK, EK CAST, EK HOTEL or WiFi by EK installations

SWG 24 L2

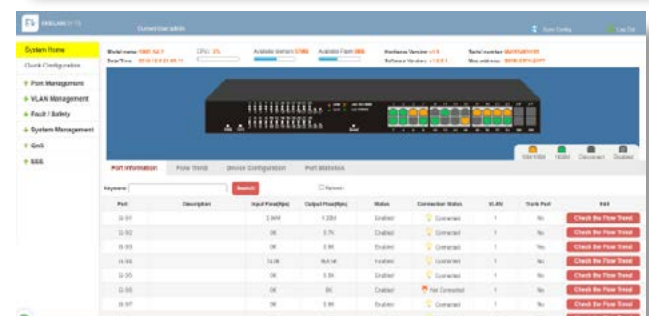
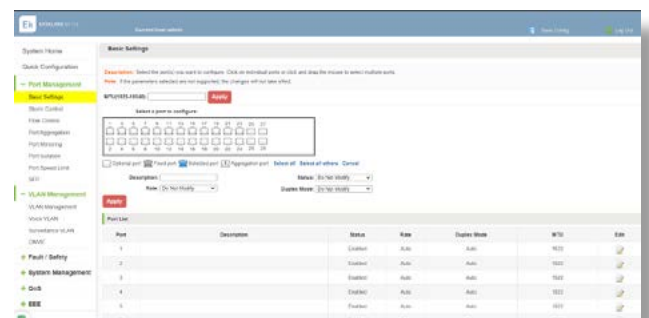

# ELECTRÓNICA DE RED

REFERENCE	RGM
Code	280070
Specifications	
Product code	RB3011UiAS-RM
Architecture	ARM 32bit
CPU	IPQ-8064
CPU core count	2
CPU nominal frequency	1.4 GHz
Dimensions	443 x 92 x 44 mm
RouterOS license	5
Operating System	RouterOS
Size of RAM	1 GB
Storage size	128 MB
Storage type	NAND
MTBF	Approximately 200'000 hours at 25C
Tested ambient temperature	-20°C to 70°C
IPsec hardware acceleration	Yes
Powering	
Number of DC inputs	2 (DC jack, PoE-IN)
DC jack input Voltage	10-30 V
Max power consumption	30 W
Max power consumption without attachments	10 W
Cooling type	Passive
PoE in	Passive PoE
PoE in input Voltage	10-30 V
PoE-out	
PoE-out ports	Ether10
PoE out	Passive PoE
Max out per port output (input 18-30 V)	600 mA
Max total out (A)	600 mA
Ethernet	
10/100/1000 Ethernet ports	10
Fiber	
SFP ports	1
Peripherals	
Serial console port	RJ45
Number of USB ports	1
USB Power Reset	Yes
USB slot type	USB 3.0 type A
Max USB current (A)	1
Other	
PCB temperature monitor	Yes
Voltage Monitor	Yes

## RGM

- ✓ Router multipuerto (10 x 1Gb) para instalaciones GPON, EK HOTEL TV, EK CAST y WiFi.



RGM



Back detail

REFERENCE	OLT 8E
Code	310008
Interfaces	
Switching capacity	60 Gbps
PON Interfaces	8 SFP GPON ports
Uplink interfaces	2 SFP 10GE / 1GE ports 8 SFP GE ports
Other interfaces	1 USB 1 FE management port
GPON Features	
PON standards and characteristics	ITU-T G.984.x Up to 128 ONTs for each PON port and up to 1000 T-CONT Management of up to 5 types of width profiles T-CONT band Adaptive bandwidth DBA algorithm Supports various authentication systems ONTs: SN, password, SN + password, Loid, Password
Ethernet Features	
VLAN	Up to 4000 VLAN inputs VLAN stacking (Q-in-Q) VLAN management by ONT service
STP protocol	IEEE 802.1D STP IEEE 802.1w RSTP IEEE 802.1s MSTP
Ports	Control de ancho de banda bidireccional Agregación virtual de enlaces estática y dinámica LACP Port mirroring y traffic mirroring
Multicast	Multicast estático IGMP v1/v2/v3 IGMP Snooping / Proxy
QoS	It allows to limit the speed on the port or on the defined service. Allows priority observation based on port or defined service and provides 802.1P and DSCP priority. QoS management over the port or over the defined service, supports 8 queues, algorithms SP, WRR or SP + WRR
User security	Protection against ARP-flooding Protection against ARP-spoofing Supports port isolation and ONU isolation control Allows IP, MAC, VLAN and port binding
Device security	Supports port isolation and ONU isolation control Allows IP, MAC, VLAN and port binding
Network security	Broadcast / multicast suppression per port ACL Flow Filtering Mechanism
Management	
Network management	CLI command line SWH-TR
General characteristics	
Operating temperature	-5 - 55°C
Feeding	AC: 100 – 240 VAC 47 – 63 Hz DC: Input -40V / -75V (Optional) Redundant power supply included
Consumption	56W (typ) / 80W (máx)
Dimensions	440 x 320 x 44,2 mm
Weight	3,5 kg (aprox.)

## OLT 8E

- ✓ Header for GPON networks. Line terminal
- ✓ Intuitive setup using SWH-TR server
- ✓ 8 downlink GPON ports
- ✓ 2 uplink 10GE / GE ports + 6 uplink GE ports
- ✓ Redundant power supply
- ✓ Compatible with ITU-T G.984.x and ITU-T G.988 standard, meets all requirements for band networking
- ✓ Ultra wide FTTH
- ✓ Maximum downstream speed 2.5 Gbps and upstream 1.25 Gbps
- ✓ ONT remote management with OMCI protocol
- ✓ 1U rack



OLT 8E



REFERENCE	OLT 16E
Code	310009
Interfaces	
Switching capacity	60 Gbps
PON Interfaces	16 ports SFP GPON
Uplink Interfaces	2 ports SFP 10GE / 1GE 6 ports SFP 1 GE
Other interfaces	1 USB 1 FE management port
GPON specifications	
PON standard and characteristics	ITU-T G.984.x Up to 128 ONTs per each PON port and up to 1000 T-CONT Up to five profiles of T-CONT bandwidth management DBA algorithm for adaptive bandwidth Different authentication types of ONT's: SN, password, SN+password, Loid, Loid Password
Ethernet specifications	
VLAN	Up to 4000 VLAN inputs VLAN stacking (Q-in-Q) ONT management of VLAN services
STP Protocols	IEEE 802.1D STP IEEE 802.1w RSTP IEEE 802.1s MSTP
Ports	Two-way bandwidth control Static and dynamic virtual links LACP aggregation Port & traffic mirroring
Multicast	Static multicast IGMP v1/v2/v3 IGMP Snooping / Proxy
QoS	Allows speed limitation on the port or defined service Allows port-based or service-based priority observation and offers 802.1P and DSCP priority Port and defined service QoS support. Supports eight queues, SP algorithms, WRR or SP + WRR
Device security	ARP-flooding protection ARP-spoofing protection Supports port isolation and ONT isolation control Allows IP, MAC, VLAN and port linkage
Network security	Port broadcast multicast suppression ACL flow filtering mechanism
Management	
Network management	CLI command line SWH - TR
General specifications	
Working temperature	-5 - 55°C
Mains feeding	AC: 100 - 240 VAC / 47 - 63 Hz DC: Input -40V / -75V (Optional) Included redundant power supply
Consumption	56W (typ) / 80W (max)
Dimensions	440 x 320 x 44,2 mm
Weight	3,5 kg (aprox.)

## OLT 16E

- ✓ Header for GPON networks. Line terminal
- ✓ Intuitive setup using SWH-TR server
- ✓ 16 downlink GPON ports
- ✓ 2 uplink 10GE / GE ports + 6 uplink GE ports
- ✓ Redundant power supply
- ✓ Compatible with ITU-T G.984.x and ITU-T G.988 standard, meets all requirements for band networking
- ✓ ultra wide FTTH
- ✓ Maximum downstream speed 2.5 Gbps and upstream 1.25 Gbps
- ✓ Remote management using SNMP protocol and remote management of ONTs using OMCI protocol
- ✓ 1U rack



# APPLICATION EXAMPLE

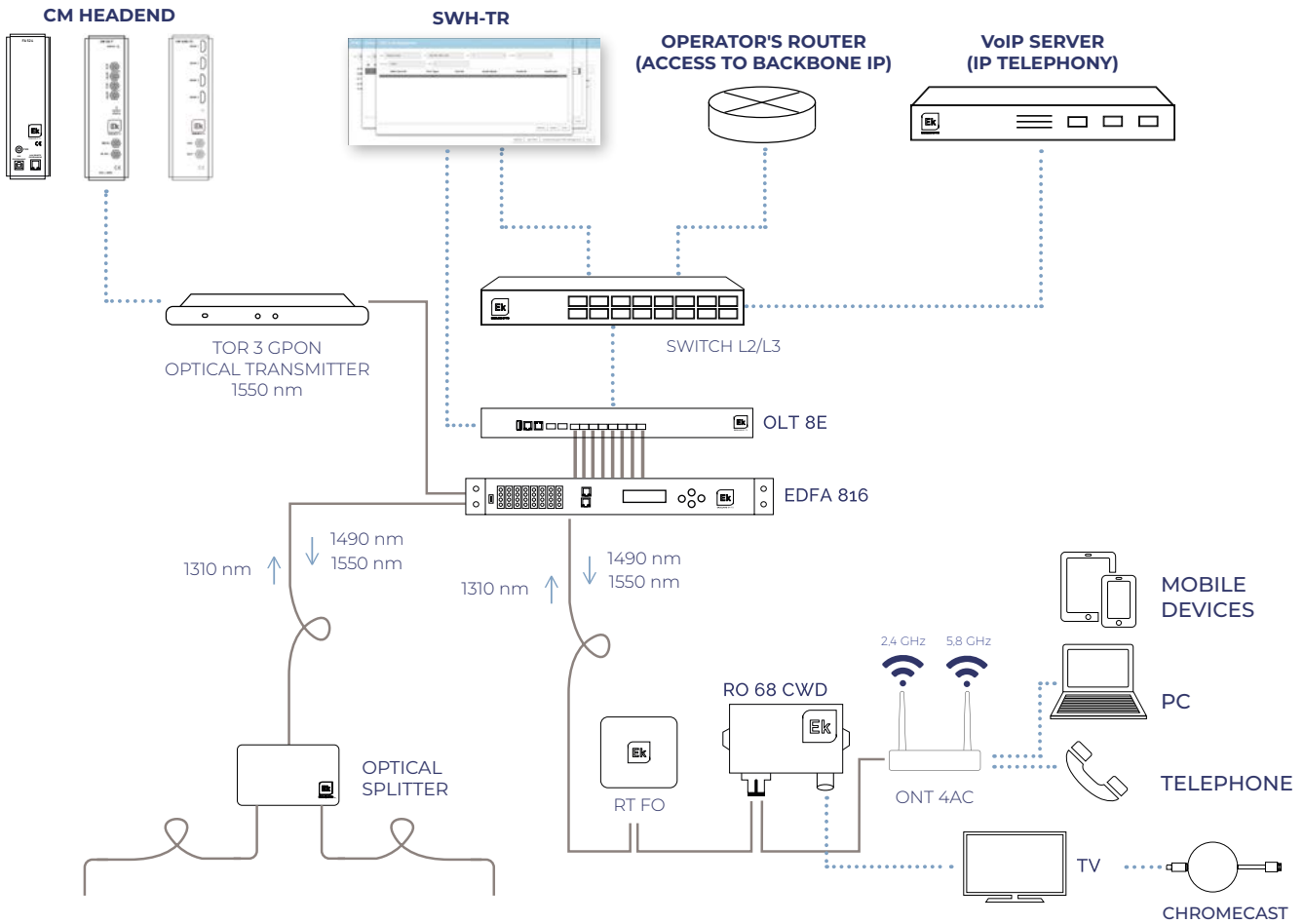

# CONFIGURATION SERVER

## OLT Configuration

- ✓ Profile and VLAN configuration
- ✓ Uplink Port Configuration
- ✓ Multicast Configuration
- ✓ OLT restart
- ✓ OLT Factory Reset

## ONTs configuration

- ✓ Configuration of private ONT parameters: Wifi, VoIP, port assignment to VLAN
- ✓ Automatically apply template to ONTs in bulk
- ✓ Manual configuration of ONTs by groups or individually
- ✓ Management IP allocation to each ONT automatically
- ✓ Group ONTs firmware update
- ✓ Resetting ONTs individually or in groups
- ✓ Factory reset of ONTs individually or in groups

## General characteristics

- ✓ Dedicated server
- ✓ Management web interface
- ✓ Import and export of complete system configuration
- ✓ Guaranteed compatibility with Chrome browser

## SWH-TR

- ✓ Configuration system for GPON networks in hospitality environments
- ✓ Complete and intuitive view of the system from the main page
- ✓ OLT and ONTs unified configuration, including WIFI and VoIP



SWH TR





# OPTICAL TRANSMITTER FOR RF OVERLAY HEADBOARDS

## TOR 3 GPON · TOR 3 GPON FI

REFERENCE		TOR 3 GPON	TOR 3 GPON FI
Code		271021	271020
RF Input			
Frequency	MHz	47 - 1000	47 - 2600
Flatness	dB	≥1	≥1
Input level (CAG)	dBμV	77 - 87*	77 - 87*
Return loss	dB	≥16	≥16
Input connector		F	F
Output test	dB	-20	-20
Optical output			
Wavelength	nm	1550	1550
Optical power	dBm	3	3
Light source		DFB	DFB
Optical return loss	dB	>50	>50
Optical connector		SC/APC	SC/APC
GENERAL			
Feeding	Vac / Hz	90-265 / 50-60	90-265 / 50-60
Consumption	W	<14	<14
Working temperature	°C	-20...55	-20...55

- ✓ 1 GHz and 2.6 GHz optical transmitters compatible with GPON installations
- ✓ Allows radio frequency signal distribution within the GPON network
- ✓ One 19" rack unit



# EDFAs GPON FOR RF OVERLAY

REFERENCE		EDFA 816	EDFA 812	EDFA 1617	EDFA 3219
Code		310010	310023	310011	310022
Connections					
Number of optical ports for OLT	N.	8	8	16	32
Number of output optical ports	N.	8	8	16	32
Input					
Working wavelength (CATV)	nm	1540 - 1563			
Pass wavelength (OLT)	nm	1310 / 1490			
Input optical power (CATV)	dBm	±10			
Output					
Total output optical power	dBm / mW	27/500	24/250	31/1260	37/5000
Output optical power adjustment	dB	0..6			
Optical output power per port	dBm	16	12	16,5	19,2
Difference of each output port optical power	dB	±0,5			
Attenuation working wavelength (CATV)	dB	<0,8			
OLT wavelength attenuation	dB	<0,8			
Optical power monitor	dB	-20			
Polarization dependence Loss / Gain	dB	0,3 / 0,4			
Noise Figure	dB	<5,5			
IN - OUT					
CATV - OLT Isolation	dB	>40			
IN - OUT Isolation	dB	30			
Optical connectors		SC/APC			
Mains feeding					
Voltage	Vac / Hz	90-265 / 50-60			
Consumption	W	<50			
Number of PSUs	N.	2			
General					
Management interface		SNMP - RJ45			
Serial Interface		RS-232			
Ports		Ethernet - LAN RJ45			
Display / Buttons		LCD /4			
STATUS LEDs		Pump, Input, Alarm, Power 1, Power 2			
Working temperature	°C	-5...65			
Dimensions	mm	1xU Rack 19"			2xU Rack 19"

## EDFA 812 / 816 / 1617 / 3219

- ✓ Compatible with FTtx PON (EPON / GEAPON / GPON)
- ✓ Models of 8, 16 and 32 optical output ports with powers from 8 to 19 dBm per port
- ✓ Low noise pre amp Very low degradation of CNR and MER
- ✓ Avoid the need to cascade different EDFAs
- ✓ Very low noise figure
- ✓ Redundant power supply
- ✓ Control and monitoring via SNMP

EDFA 812  
/ 816



EDFA 1617  
/ 3219



# APPLICATION EXAMPLE

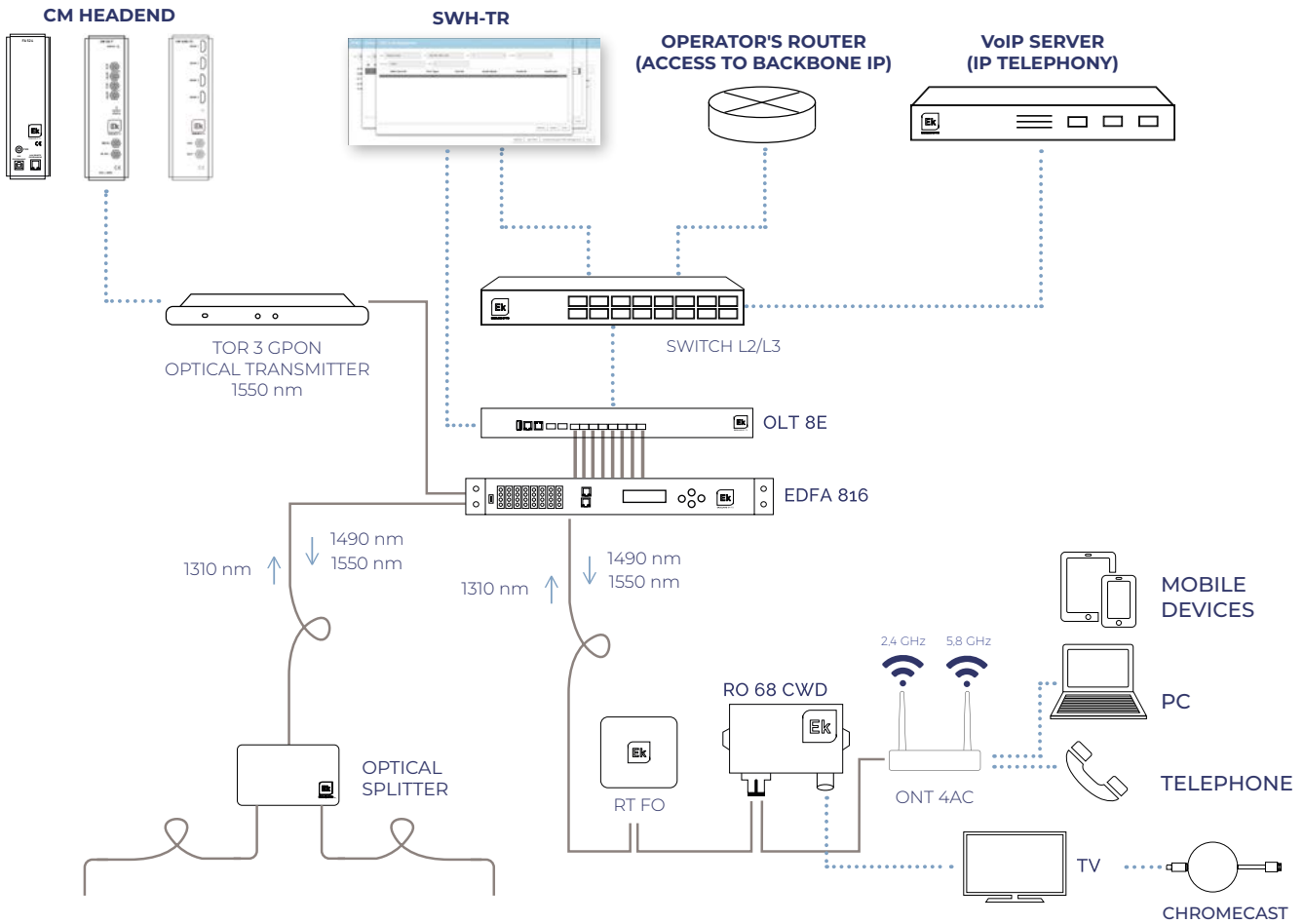

# GPON / FTTH OPTICAL NETWORK TERMINAL

REFERENCE	ONT 2W
Code	310032
GPON specifications	
Transfer speed	Downstream: 2.488Gbps Upstream: 1.244Gbps
Connector	SC/APC
Optical	ITU-T G.984.2 Clase B+
Standards	ITU-T G.984.x (G.984.5 support) FCC 47 CFR Part 15, Class B FDA 21 CFR 1040.10 & 1040.11, Class I IEEE 802.3 Ethernet 802.1 q/p VLANs
Optical wavelength and power	Downlink Wavelength: 1490nm Sensitivity: -28dBm Saturation: -8dBm Uplink Wavelength: 1310nm Transmission power: 0.5 - 5dBm
Fiber mode	G.652 Monomode
Others	32 T-CONTs 256 GEM Flexible mapping between GEM ports and T-CONTs Upstream and downstream FEC (Forward Error Correction) Automatic discovery of SN and password activation AES-128 encryption with keys generation and conmutation 802.1p service upstream
Ethernet specifications	
Standards	IEEE802.3 / IEEE802.3au / IEEE802.3x
Interfaces	2 ports 10/100/1000BASE-T port. RJ45 Connector Auto negotiation Auto MDI/MDIX
Router functionality (switching & routing)	Bridging & Switching ( 802.1d / 802.1q) 8 clases de tráfico (802.1p) Control de flujos 802.3n Etiquetado y filtrado de VLAN VLAN stacking ( Q-in-Q ) IGMP multicast para video IPTV IGMP snooping RSTP IPHOST SSH QOssp, WRR, SP+WRR Port Mirror
WiFi specifications	
Standard	IEEE 802.11 b/g/n (Up to 300 Mbps throughput)
Frequency	2,4 GHz / 300Mbps
Antenna	2x2, 5dBi
EIRP	Max 25dBm
Others	Up to 4 possible SSID's Up to 64 simultaneous connections WEP, WPA-PSK, WPA2-PSK (AES, TKIP) Security MAC filtering
POTS Telephony specifications	
REN	Max 5REN
Connector	1 port RJ11
Call Voltage	65V RMS
Protocols	SIP / MGCP G.711 (A- & u-), G.729, G.726 codec DTMF Calling Echo suppression support, VAD, CNI Call identification, hold call, forward call, 3-users call T.30 & T.38 FAX
USB	
Function mode	Host / device
Current	Max 1A
General specifications	
Working temperature	-5~45°C
Voltage	12V DC1.5A max
Dimensions	244 x 161 x 41 mm
Weight	500g (aprox.)

## ONT 2W

- ✓ GPON Optical Network Unit for SOHO and residential purposes
- ✓ 2 x Autoadaptive 10/100/1000Base-T Ethernet ports
- ✓ WiFi 2x2 802.11 n (Up to 300Mbps of wireless throughput)
- ✓ 1x POTS telephony port
- ✓ Allows access to ultra high speed networks: Internet, VoIP and IPTV
- ✓ Compatible with ITU-T G.984.x standard. Meets all requirements for creating ultra high speed FTTH networks
- ✓ 2.5Gbps maximum downlink / 1.25 Gbps uplink speed
- ✓ Local and remote management. OMCI, Web, CLI and SNMP
- ✓ Compatible and interoperable with the Ekselans by ITS OLTs and other main brands in the market



# APPLICATION EXAMPLE

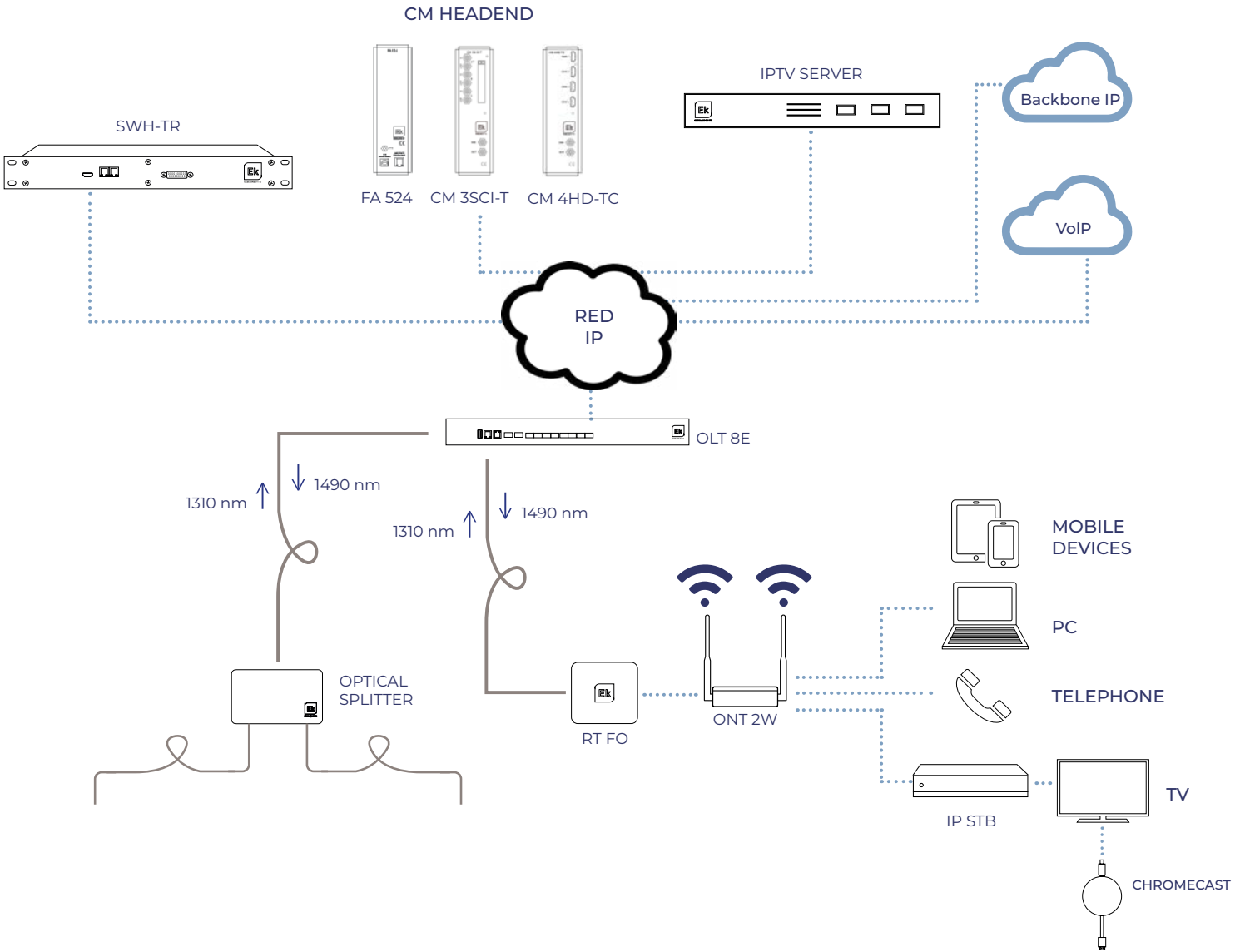

# GPON / FTTH OPTICAL NETWORK TERMINAL

REFERENCE	ONT 4 AC
Code	310017
GPON specifications	
Transfer speed	Downstream: 2.488Gbps Upstream: 1.244Gbps
Connector	SC/APC
Optical	ITU-T G.984.2 Clase B+
Standards	ITU-T G.984.x (G.984.5 support) FCC 47 CFR Part 15, B Class FDA 21 CFR 1040.10 & 1040.11, Class I IEEE 802.3 Ethernet 802.1 q/p VLANs
Optical wavelength and power	Downlink Wavelength: 1490nm Sensitivity: -28dBm Saturation: -8dBm Uplink Wavelength: 1310nm Transmission power: 0.5 - 5dBm
Fiber mode	G.652 Monomode
Others	32 T-CONTs 256 GEM Flexible mapping between GEM ports and T-CONTs Upstream and downstream FEC (Forward Error Correction) Automatic discovery of SN and password activation AES-128 encryption with keys generation and commutation 802.1p service upstream
Ethernet specifications	
Standards	IEEE802.3 IEEE802.3au IEEE802.3x
Interfaces	4 ports 10/100/1000BASE-T port. RJ45 Connector Auto negotiation Auto MDI/MDIX
Router functionality (switching & routing)	Bridging & Switching ( 802.1d / 802.1q) 8 traffic classes (802.1p) Flow control 802.3n VLAN labelling and filtering VLAN stacking ( Q-in-Q ) IGMP multicast for IPTV video IGMP snooping RSTP IPHOST SSH QOS (SP, WRR, SP+WRR) Port Mirror
WiFi specifications	
Standard	IEEE 802.11 b/g/n (hasta 300 Mbps de transferencia)
Antenna	2x2, 5dBi
EIRP	Max 25dBm
Others	Up to 4 possible SSID's Up to 64 simultaneous connections WEP, WPA-PSK, WPA2-PSK (AES, TKIP) Security MAC filtering
POTS Telephony specifications	
REN	Max 5REN
Connector	2 ports RJ11
Call Voltage	65V RMS
Protocols	SIP / MGCP G.711 (A- & u-), G.729, G.726 codec DTMF Calling Echo suppression support, VAD, CNI Call identification, hold call, forward call, 3-users call T.30 & T.38 FAX
USB	
Funtion mode	Host / device
Current	Max 1A
Características generales	
Working temperature	-5~45°C
Voltage	12V DC1.5A max
Dimensions	244 x 161 x 41 mm
Weight	500g (aprox.)

## ONT 4AC

- ✓ GPON Optical Network Unit for SOHO and residential purposes
- ✓ 4x Autoadaptive 10/100/1000Base-T Ethernet ports
- ✓ WiFi 3x3 802.11 b/g/n 2.4GHz and 3x3 802.11 n/ac 5.8 GHz
- ✓ 2x POTS telephony ports
- ✓ 1 USB port
- ✓ Allows access to ultra high speed networks: Internet, VoIP and IPTV
- ✓ Compatible with ITU-T G.984.x standard. Meets all requirements for creating ultra high speed FTTH networks
- ✓ 2.5Gbps maximum downlink / 1.25 Gbps uplink speed
- ✓ Local and remote management. OMCI, Web, CLI and SNMP
- ✓ Compatible and interoperable with the Ekselans by ITS OLTs and other main brands in the market



# APPLICATION EXAMPLE

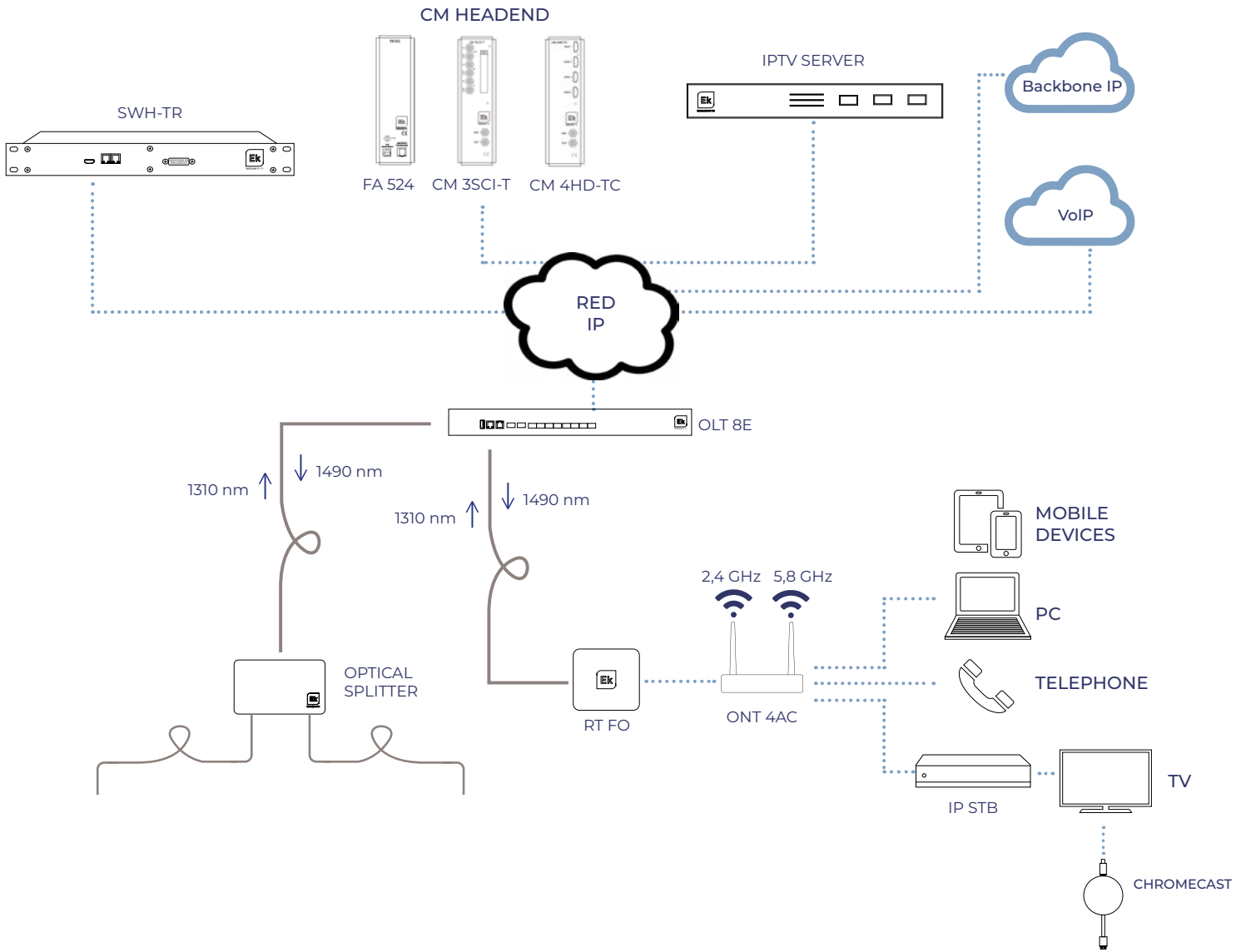

# PoE GPON OPTICAL NETWORK TERMINAL

REFERENCE	ONT 4 POE
Code	310033
GPON specifications	
Transfer speed	Downstream: 2.488Gbps / Upstream: 1.244Gbps
Connector	SC/APC
Optical	ITU-T G.984.2 Clase B+
Standards	ITU-T G.984.x (G.984.5 support) FCC 47 CFR Part 15, Class B FDA 21 CFR 1040.10 & 1040.11, Class I IEEE 802.3 Ethernet 802.1 q/p VLANs
Optical wavelength and power	Downlink Wavelength: 1490nm Sensitivity: -28dBm Saturation: -8dBm Uplink Wavelength: 1310nm Transmission power: 0.5 - 5dBm
Fiber mode	G.652 Monomodo
Others	32 T-CONTs 256 GEM Flexible mapping between GEM ports and T-CONTs Upstream and downstream FEC Automatic discovery of SN and password activation AES-128 encryption with keys generation and conmutation 802.1p service upstream FEC (Forward Error Correction)
Ethernet specifications	
Standards	IEEE802.3 / IEEE802.3au / IEEE802.3x
Interfaces	4 ports 10/100/1000BASE-T. Conector RJ45 Auto negotiation Auto MDI/MDIX 100m de distance 48V PoE power supply 60W maximum power
Router functionality (switching & routing)	Bridging & Switching ( 802.1d / 802.1q) 8 traffic classes (802.1p) Flow control 802.3n VLAN filtering and labeling VLAN stacking ( Q-in-Q ) IGMP multicast para video IPTV IGMP snooping RSTP IPHOST SSH QOSSP, WRR, SP+WRR Port Mirror
General specifications	
Working temperature	-5~45°C
Voltage	12V DC1.5A max
Dimensions	244 x 161 x 41 mm
Weight	500g (aprox.)

## ONT 4 POE

- ✓ GPON Optical Network Unit for SOHO and residential purposes
- ✓ 4x Autoadaptive 10/100/1000 Base-T Ethernet ports with PoE 48V power supply
- ✓ Compatible with ITU-T G.984.x standard. Meets all requirements for creating ultra high speed FTTH/ FTTR networks
- ✓ 2.5Gbps maximum downlink / 1.25 Gbps uplink speed
- ✓ Allows access to ultra-broadband services: internet, VoIP and IPTV
- ✓ Local and remote management. OMCI, Web, CLI and SNMP
- ✓ Compatible and interoperable with the Ekselans by ITS OLTs



ONT4 POE



# APPLICATION EXAMPLE

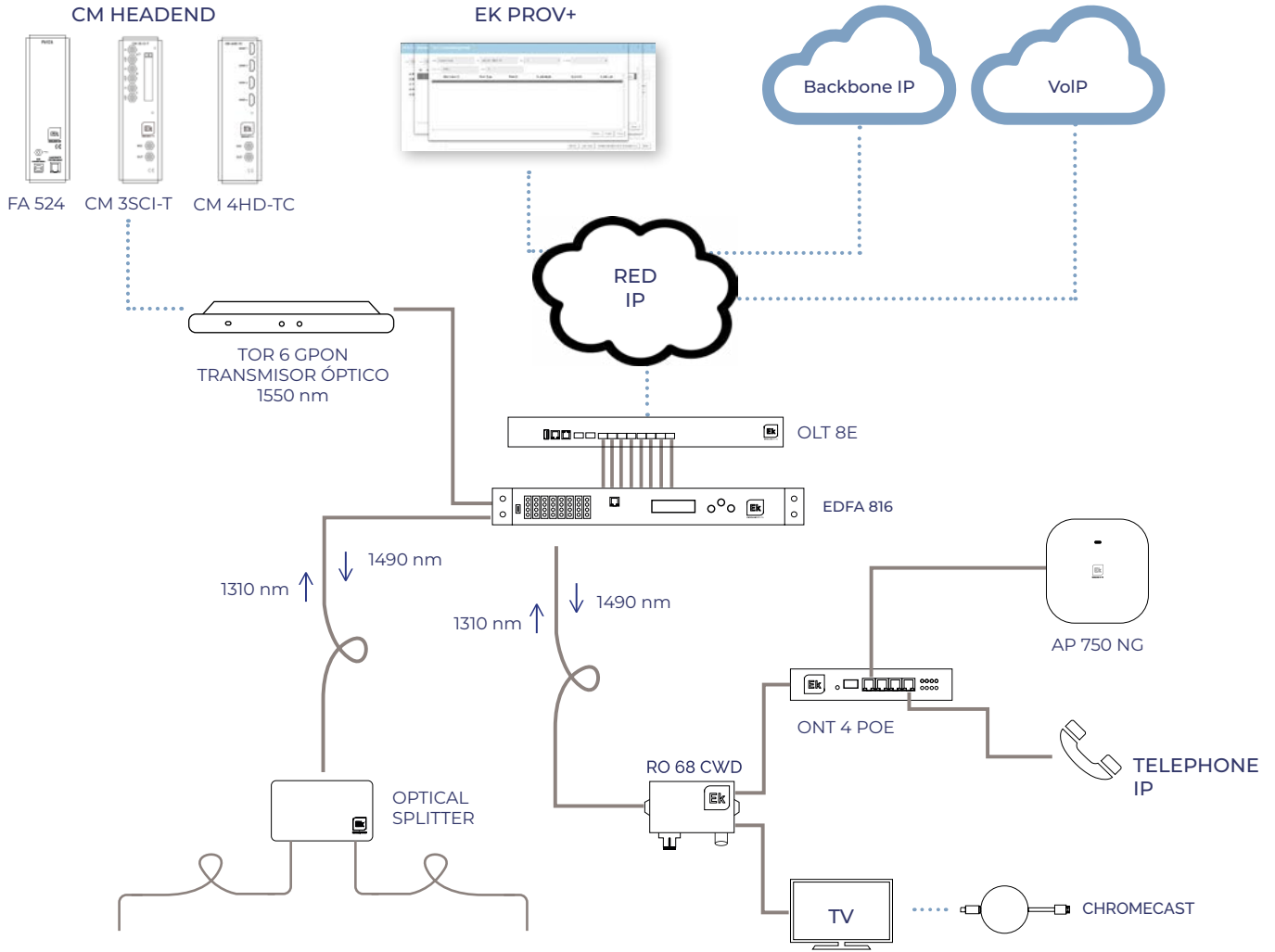

# PoE GPON OPTICAL NETWORK TERMINAL

REFERENCIA	ONT 4 POE CP
Code	310047
GPON specifications	
Transfer speed	Dowstream: 2.488Gbps / Upstream: 1.244Gbps
Connector	SC/APC
Optical	ITU-T G.984.2 Clase B+
Class B+ Standards	ITU-T G.984.x (G.984.5 support) FCC 47 CFR Part 15, Class B FDA 21 CFR 1040.10 & 1040.11, Class I IEEE 802.3 Ethernet 802.1 q/p VLANs
Optical wavelength and power	Downlink: Wavelength: 1490nm Sensitivity: -28dBm Saturation: -8dBm Uplink: Wavelength: 1310nm Transmission power: 0.5 ~ 5dBm
Fiber mode	G.652 Monomodo
Others	32 T-CONTs 256 GEM Flexible mapping between GEM ports and T-CONTs Upstream and downstream FEC Automatic discovery of SN and password activation AES-128 encryption with keys generation and conmutation 802.1p service upstream FEC (Forward Error Correction)
Ethernet specifications	
Standards	IEEE802.3 / IEEE802.3au / IEEE802.3x
Interfaces	4 ports 10/100/1000BASE-T. Connector RJ45 Auto negotiation Auto MDI/MDIX 100m de distance 48V PoE power supply Maximum total power 60W (maximum 30w per port)
Router functionality (switching & routing)	Bridging & Switching ( 802.1d / 802.1q) 8 traffic classes (802.1p) 802.3n flow control VLAN* tagging and filtering VLAN stacking ( Q-in-Q ) IGMP multicast for IPTV IGMP snooping RSTP IPHOST SSH QOSSP, WRR, SP+WRR Port Mirror
POTS Telephony specifications	
REN	Max 5REN
Connector	2 ports RJ11
Call Voltage	65V RMS
Protocols	SIP / MGCP G.711 (A- & u-), G.729, G.726 codec Llamada DTMF DTMF Calling Echo suppression support, VAD, CNI Call identification, hold call, forward call, 3-users call T.30 & T.38 FAX
General specifications	
Working temperature	-30~55°C
Power supply	48V dc / 1.35A (64.8W)
Dimensions	150 x 115 x 30 mm
Weight	500g (aprox.)

## ONT 4 POE CP

NEW

- ✓ GPON Optical Network Terminal and gateway for SOHO and residential purposes
- ✓ 4 x Self-adaptative 10/100/1000Base-T Ethernet ports with 48V PoE power supply
- ✓ Also includes 2 RJ 11 analog telephone ports (POTS)
- ✓ Compatible with ITU-T G.984.x standard. Meets all requirements for creating ultra high speed FTTH/ FTTR networks
- ✓ 2.5Gbps maximum downlink / 1.25 Gbps uplink speed
- ✓ Allows access to ultra-broadband services
- ✓ Local and remote management. OMCI, Web, CLI and SNMP
- ✓ Compatible and interoperable with OLTs Ekselans by ITS



ONT 4  
POE CP

# APPLICATION EXAMPLE

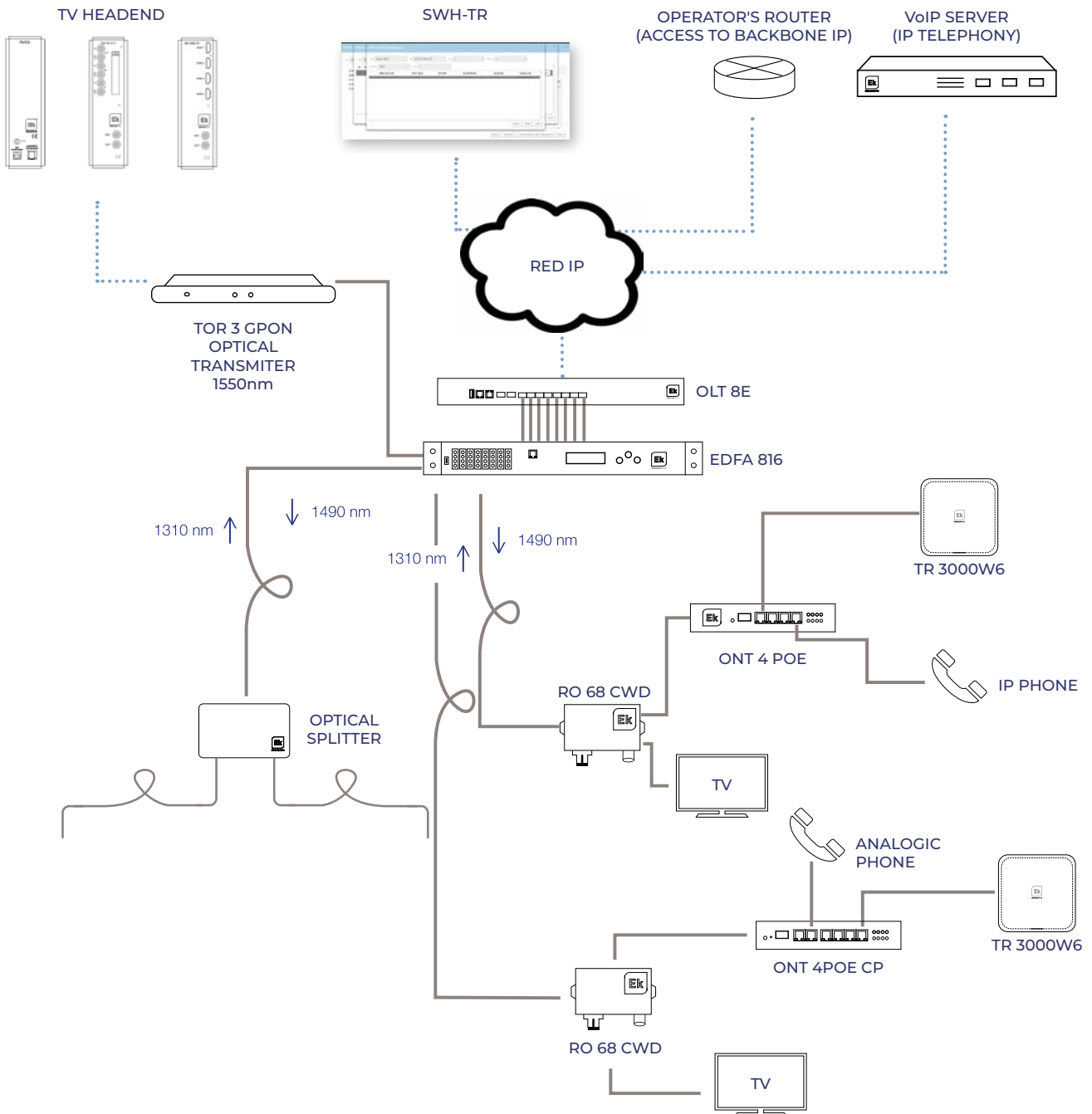

# OPTICAL RECEIVERS FOR GPON INSTALLATIONS

## RO 68 CWD · RO 88 CWD · RO 65 FI CWD RO 90 FI CWD

- ✓ It allows the reception of optical signal and can continue distributing it in radio frequency
- ✓ Compatible with GPON networks. Wavelength step 1310/1490 nm
- ✓ RO 68 CWD: passive behavior. Does not need power



RO 68 CWD



RO 88 CWD

REFERENCIA		RO 68 CWD	RO 88 CWD	RO 65 FI CWD	RO 90 FI CWD
Código		270005	270004	270006	270007
Optical input					
Wavelength	nm	1540 - 1563	1540 - 1563	1540 - 1563	1540 - 1563
Pass wavelength	nm	1310 / 1490	1310 / 1490	1310 / 1490	1310 / 1490
Optical input level	dBm	0 / -10	+2 / -20	0 / -10	+3 / -15
AGC range	dBm	-	0 / -12	-	+2 / -7
Efficiency	A/W	≥0,9/1550 nm	≥0,85/1310 nm ≥0,9/1550 nm	≥0,9/1550 nm	≥0,9/1310 nm ≥0,95/1550 nm
Optical return loss	dB	>45	>45	>45	>45
Optical connector	-	SC/APC (IN/OUT)	SC/APC (IN/OUT)	SC/APC (IN/OUT)	SC/APC (IN/OUT)
RF Output					
Frequency range	MHz	47 - 1000	47 - 1000	47 - 2350	47 - 2150
Flatness	dB	±1	±0,75	±1,5	±0,75
Output level	dBμV	62 @ -1dBm*	>80 (AGC)*	60 @ -1dBm**	>80 (AGC)**
Output level regulation	dB	-	0 - 20	-	0 - 20
MER	dB	≥31dB	≥31dB	≥31dB	≥31dB
VBER	-	1E-8	1E-8	1E-8	1E-8
Return loss	dB	≥14	≥14	≥14	≥14
Output connector	-	F	F	F	F
General					
Voltage feeding	Vdc	Not required	12 (PSU included)	Not required	12 (PSU included)
Dimensions	mm	73 x 103 x 23			
Power consumption	W	-	≤1	-	≤1
Working temperature	°C	-20 / +55	-20 / +55	-20 / +55	-20 / +55

# APPLICATION EXAMPLE

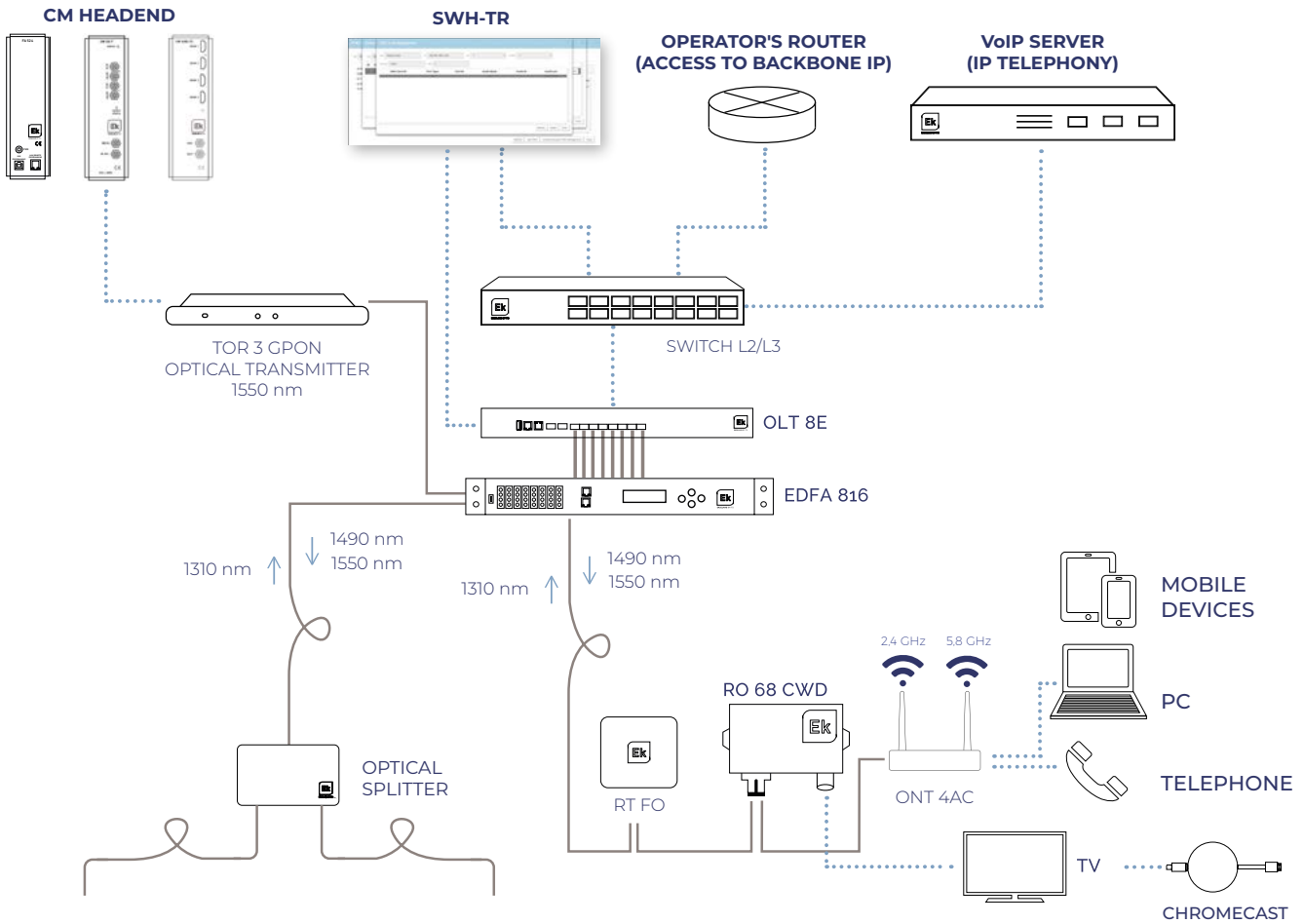

# GPON PoE OPTICAL NETWORK TERMINAL

REFERENCE	ONT 4 POE IN
Code	310037
GPON specifications	
Transfer speed	Dowstream: 2.488Gbps / Upstream: 1.244Gbps
Connector	SC/APC
Optical	ITU-T G.984.2 Class B+
Class B+ Standards	ITU-T G.984.x (G.984.5 support) FCC 47 CFR Part 15, Class B FDA 21 CFR 1040.10 & 1040.11, Class I IEEE 802.3 Ethernet 802.1 q/p VLANs
Optical wavelength and power	Downlink: Wavelength: 1490nm Sensitivity: -28dBm Saturation: -8dBm Uplink: Wavelength: 1310nm Transmission power: 0.5 ~ 5dBm
Fiber mode	G.652 Monomodo
Others	32 T-CONTs 256 GEM Flexible mapping between GEM ports and T-CONTs Upstream and downstream FEC Automatic discovery of SN and password activation AES-128 encryption with keys generation and conmutation 802.1p service upstream FEC (Forward Error Correction)
Ethernet specifications	
Standards	IEEE802.3 / IEEE802.3au / IEEE802.3x
Interfaces	4 ports 10/100/1000BASE-T port. RJ45 Connector Auto negotiation Auto MDI/MDIX 100m de distance 48V PoE power supply 60W max power consumption
Router functionality (switching & routing)	Bridging & Switching (802.1d / 802.1q) 8 traffic classes (802.1p) 802.3n flow control VLAN tagging and filtering VLAN stacking (Q-in-Q) IGMP multicast for IPTV IGMP snooping RSTP IPHOST SSH QOSSP, WRR, SP+WRR Port Mirror
General specifications	
Working temperature	-30°C / 65°C
Power supply	12V DC1.5A max
Dimensiones	222 x 56 x 200 mm
Peso	2000g (aprox.)

## ONT 4 POE IN

- ✓ GPON network terminal specifically designed for industrial environments and outdoor installations that demands high mechanical and electrical specifications
- ✓ Aluminum metallic box format with epoxy painting, with reinforced mounting bracket for electrical panels and outdoor distribution cabinets installation
- ✓ Specific design to withstand a operating temperature environment up to 65°C
- ✓ 1 SC/APC connector
- ✓ 4 RJ45 10/100/1000Mbps self-adaptive ports with 48Vdc PoE power supply (max 60W)
- ✓ Front panel with 12 status LEDs and reset button
- ✓ Internal power supply in metallic box format. IP67 waterproof, input range 100-305Vac 47-63Hz, 96W power, typical efficiency 90% and CE, BIS, CCC, RCM, KCC, ENEC, EAC, UKCA certificates and UL
- ✓ ONT compatible and interoperable with OLTs Ekse-lans by ITS
- ✓ ONT developed according to IT-TG.984 standards and fully compatible and manageable from the SWH-TR-V, real-time monitoring software of GPON equipment for public lighting network
- ✓ ONT with encryption support, individualized for each unit installed in a FTTH network, of received data from the OLT using Advanced Encryption Standard 128 (AES128) algorithm
- ✓ SFU (Switch Fabric Unit) type ONT with IP address management assigning option for monitoring in third-party tools
- ✓ Final product designed and assembled in Spain



ONT 4  
POE IN

# APPLICATION EXAMPLE

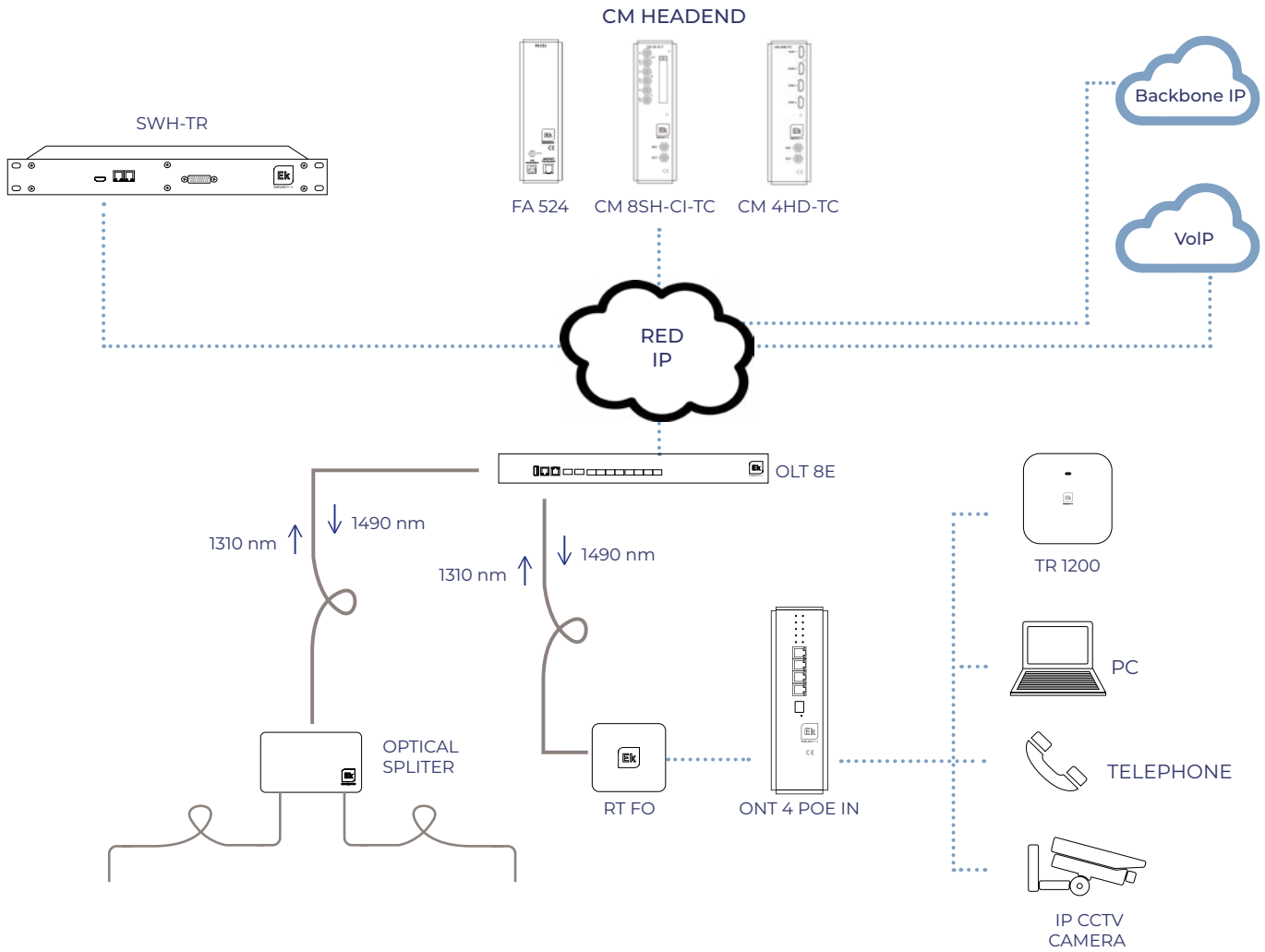

# GPON/FTTH OPTICAL NETWORK TERMINAL

REFERENCE	ONT IN	ONT IN24
Code	310029	310034
Transfer speed	Downstream: 2.488Gbps Upstream: 1.244Gbps	
Connector	SC/APC	
Optical	ITU-T G.984.2 Class B+	
Standards	ITU-T G.984.x (G.984.5 support) FCC 47 CFR Part 15, Class B FDA 21 CFR 1040.10 & 1040.11, Class I IEEE 802.3 Ethernet 802.1 q/p VLANs	
Optical wavelength and power	Downlink Wavelength: 1490nm Sensitivity: -28dBm Saturation: -8dBm Uplink Wavelength: 1310nm Transmission power: 0.5 ~ 5dBm	
Fiber mode	G.652 Monomodo	
Others	32 T-CONTs 256 GEM Flexible mapping between GEM ports and T-CONTs FEC upstream & downstream Automatic discovery of SN and password activation AES-128 encryption with keys generation and conmutation 802.1p service upstream FEC (Forward Error Correction)	
Power supply	12 Vdc 1,5A max.	24 Vdc
Ethernet specifications		
Standards	IEEE802.3 / IEEE802.3au / IEEE802.3x	
Interfaces	4 ports 10/100/1000BASE-T. Conector RJ45 Auto negotiation Auto MDI/MDIX	
Router functionality (switching & routing)	Bridging & Switching (802.1d / 802.1q) 8 traffic classes (802.1p) Flow control 802.3n VLAN filtering and labeling VLAN stacking (Q-in-Q) IGMP multicast for IPTV video IGMP snooping RSTP / IPHOST /SSH QOS-SP, WRR, SP+WRR Port Mirror	
Industrial features	Compatible with industrial PLC systems	
WiFi specifications		
Standard	IEEE 802.11 b/g/n (Up to 300 Mbps transfer rate)	
Antenna	SMA connectors for 2.4/5 GHz WiFi antennas	
EIRP	Max 25 dBm	
Others	Up to 4 possible SSID's per band Up to 64 simultaneous connections WEP, WPA-PSK, WPA2-PSK (AES, TKIP) Security MAC filtering	

## ONT IN · ONT IN 24

- ✓ Optical Network Unit and gateway for industry sector
- ✓ 4x Autoadaptative 10/100/1000 Base-T Ethernet ports
- ✓ Compatible with ITU-T G.984.x standard. Meets all requirements for creating ultra high speed FTTH networks
- ✓ 2.5Gbps maximum downlink / 1.25 Gbps uplink speed
- ✓ Allows access to ultra-broadband services: internet, VoIP and IPTV
- ✓ Local and remote management. OMCI, Web, CLI, SNMP and SWH servers
- ✓ Compatible and interoperable with the Ekselans by ITS OLTs





# APPLICATION EXAMPLE

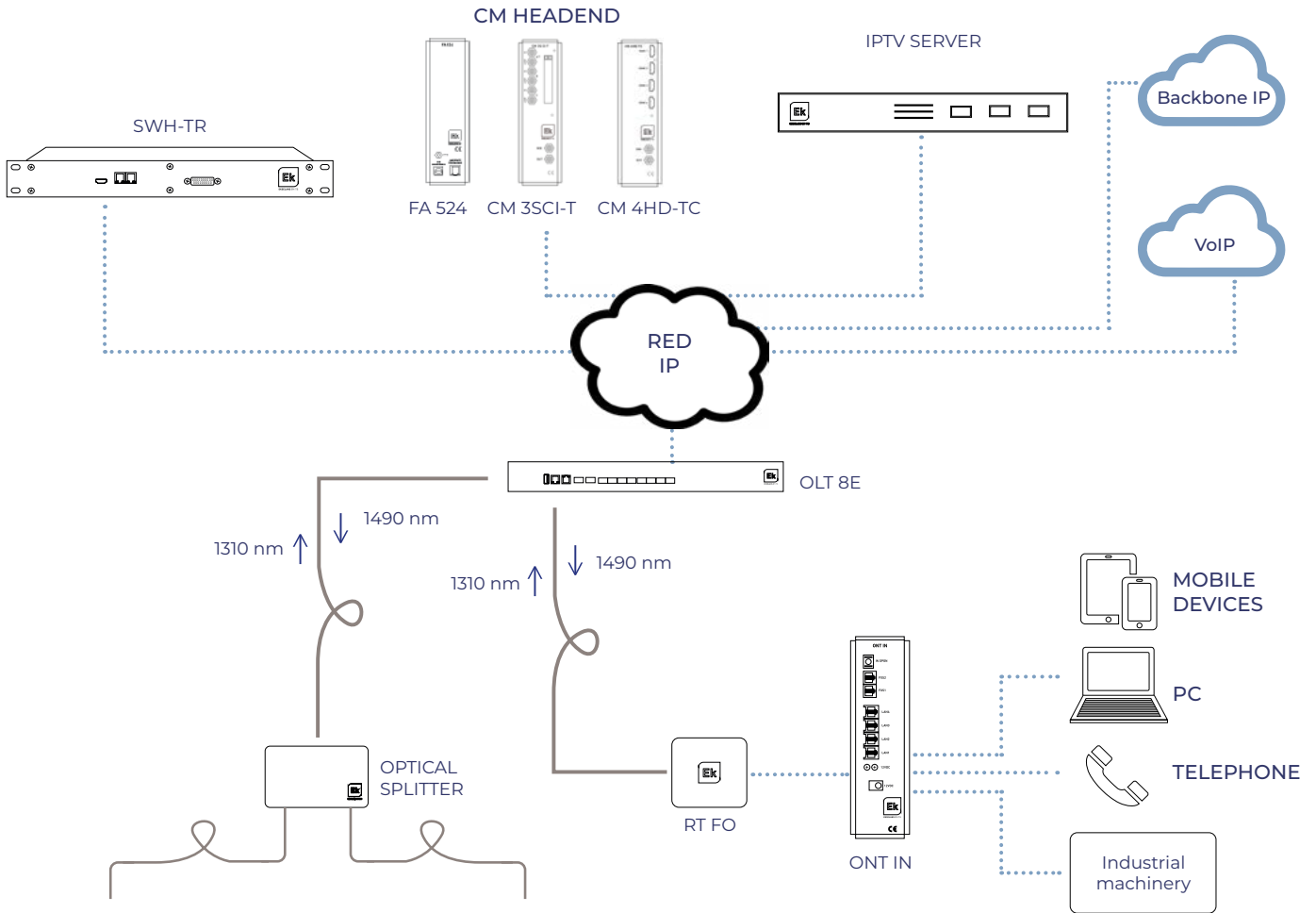

## ONTs UPS

### UPS 16 · UPS 32

REFERENCE		UPS 16	UPS 32
Code		312001	312002
Maximum input voltage	V	13	
Minimum input voltage	V	9	
Rated output voltage	V	12 ± 5%	
Maximum output current	mA	1000	
Batteries	mAh	2x 2200 (LiPo)	4x 2200 (LiPo)
Capacity	Wh	16	32
Working temperature	°C	10 ÷ 40	
Storage temperature	°C	-5 ÷ 50	
Maximum humidity	% Hum	<90	
Dimensions	cm	23 x 15 x 3	

- ✓ Uninterruptible Power Supply
- ✓ Effective management of the battery charging process
- ✓ Stackable with other units for greater autonomy
- ✓ Protected against overvoltages and short circuits
- ✓ Switch for battery disconnection
- ✓ Do not forget to connect the batteries



## ACCESSORIES FOR GPON NETWORKS

- ✓ Racks and Accessories
- ✓ Fiber trays for 19" rack
- ✓ Fiber distribution box
- ✓ Fiber distribution box
- ✓ Fiber cables
- ✓ Pigtails, patch-cords, Fiber optics terminal boxes and other accessories

BSCFR



SCF 32



NEW

RS 24-12



BF 24E



ARS 12

NEW



CFO 1900



CFD 16



PTXX F





**EKSELANS BY ITS**

**ITS Partner O.B.S. S.L**

Av. Cerdanyola 79-81 Local C

08172 Sant Cugat del Vallès

Barcelona (Spain)

Tel: +34 935839543

[info@ek.plus](mailto:info@ek.plus)

[www.ek.plus](http://www.ek.plus)