



EKSELANS BY ITS

VIDEK

2 WIRES VIDEO DOOR
ENTRY SYSTEM WITH
MIFARE RFID ACCESS
CONTROL



ENTER THE EK WORLD

2 WIRES VIDEO DOOR ENTRY SYSTEM WITH MIFARE RFID ACCESS CONTROL



General features

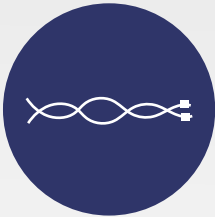

Non-polarized 2 wires system

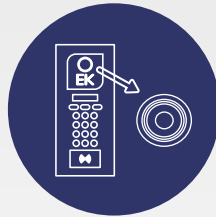

Digital outdoor panel in stainless steel with high quality color camera



Auto-adjusting light sensor



Compatible with outdoor door lock



LCD display with simple and intuitive directory



Audio call volume adjustment on monitor

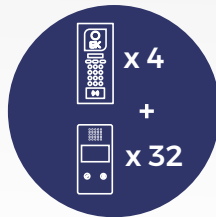

Up to 4 outdoor panels and up to 32 users (64 indoor units max)



Monitoring function. Possible to watch the street without prior call.



Easy to install and to program



Integrated MIFARE access control

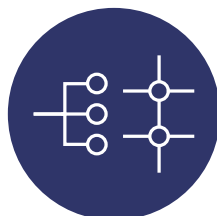

Parallel or series installation option

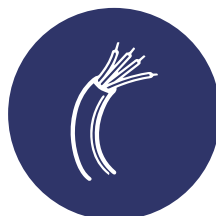

It can be used as replacement using existing cabling

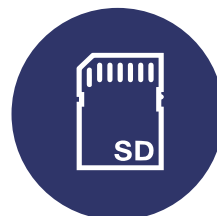

SD card slot



Additional CCTV camera option



OUTDOOR PANEL
(PCD E) WITH PLASTIC
FRAME FOR SURFACE
MOUNTING

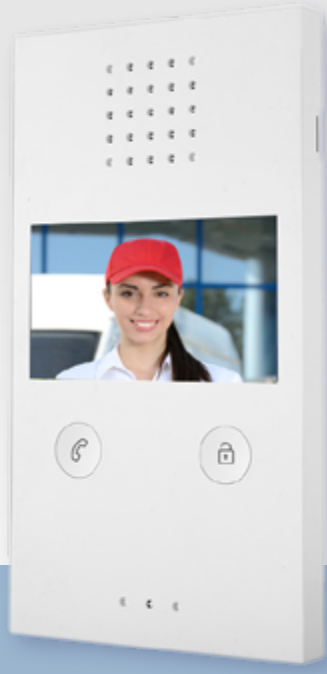

HANDS-FREE 4.3"
COLOR DISPLAY
INDOOR UNIT



HANDS-FREE
AUDIO INDOOR
UNIT



Outdoor panel

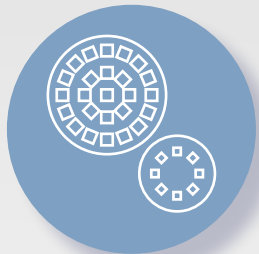

AUTO-ADJUSTING
LIGHT SENSOR



HIGH QUALITY
CAMERA



LCD DISPLAY
WITH SIMPLE AND
INTUITIVE DIRECTORY



NUMERIC KEYBOARD
TO SELECT APARTMENT
WITH DIFFERENT
PROGRAMMING MODES

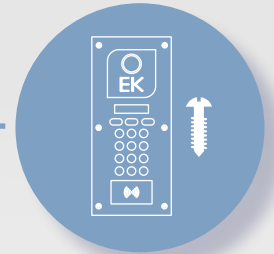

STAINLESS STEEL PANEL
WITH ANTI VANDALS
SECURITY SCREWS



MIFARE RFID
ACCESS CONTROL





**SURFACE OR FLUSH
MOUNTING OPTIONS**

**SURFACE
MOUNTING**

**FLUSH
MOUNTING**



MON 43V Monitor



- ✓ High quality 4,3" color display
- ✓ Hands-free
- ✓ Outdoor monitoring using the outdoor panel camera
- ✓ Outdoor monitoring using the outdoor panel camera

Audio indoor unit UAD



- ✓ Audio call intercom
- ✓ Hands-free
- ✓ Capacitive touch keyboard
- ✓ Wall mounting support included

PFA 2420 Power supply



- ✓ 2 wires BUS system power supply
- ✓ Central system power supply. PCD-E outdoor panel and DPL-4/ DPL-4F splitters intercom module

DPL-4/DPL-4F splitters



- ✓ 4 outputs floor splitters
- ✓ cascable and terminal models
- ✓ Splitting isolation and electrical protection for all apartment systems in the building
- ✓ Use DPL-4F terminal splitter as last splitter to close the line

Accessories

CE PCD	Flush box for PCD E
VE-AI	Stainless steel protective frame for PCD E outdoor panel
VPS	Protective plastic box for surface mounted PCD E outdoor panel
RF KEY	Mifare type RFID key
CVP 2	2-wire cable 0.5mm ² . 250m reel. Floor wiring
CVP 2-1,5	2-wire cable 1.5mm ² . 200m reel. Long distances wiring



CE PCD



VE-AI



VPS



RF KEY



**CVP2
CVP 2-1,5**

Dimensions

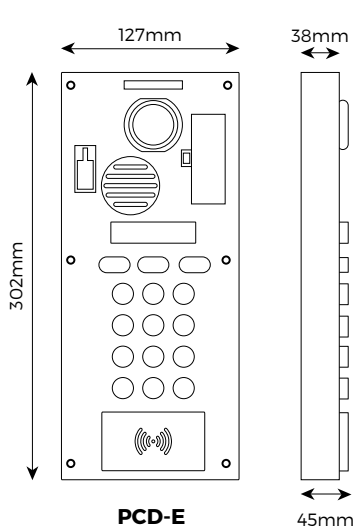

PCD-E

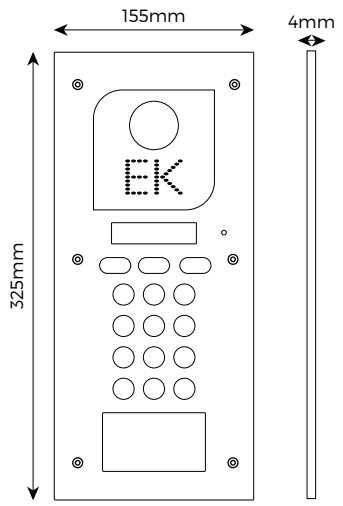

Placa Inox PCD-E

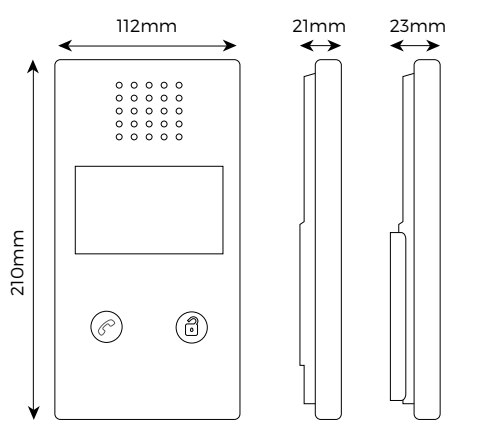

MON 43V

Lateral with and without support

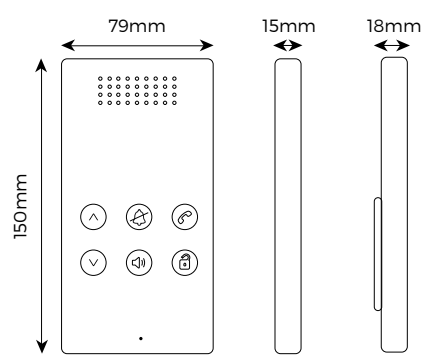

UAD

Lateral with and without support

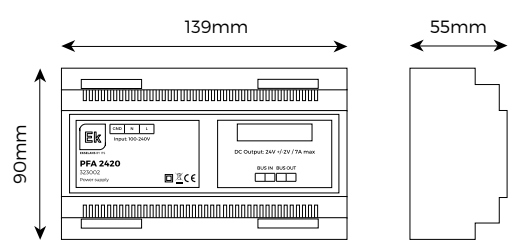

PFA 2420

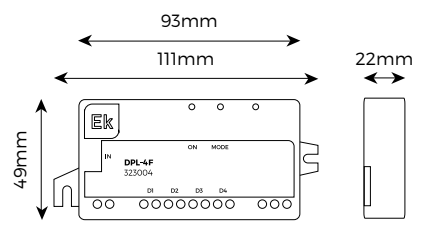

DPL-4 / DPL-4F

Examples of installation schemes

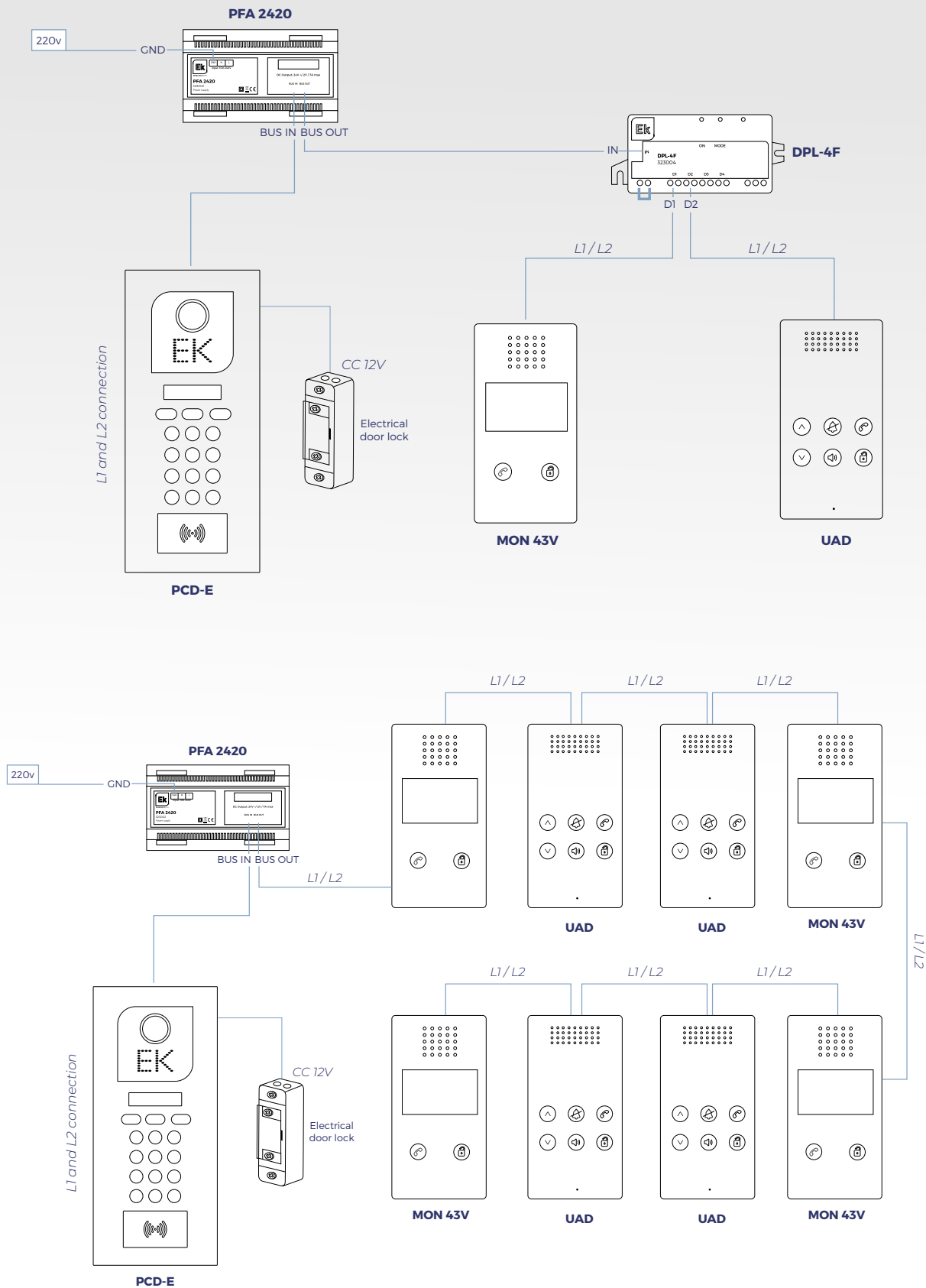



EKSELANS BY ITS

EKSELANS by ITS
ITS Partner O.B.S. S.L
Av. Cerdanyola 79-81 Local C
08172 Sant Cugat del Vallès
Barcelona (España)
Tel: +34 93 583 95 43
info@ek.plus
www.ek.plus